

bitronvideo

VIDEOCITOFONIA - TVCC

CE

MANUALE ISTRUZIONI

CARATTERISTICHE DI FUNZIONAMENTO E INSTALLAZIONE

INSTRUCTIONS MANUAL

OPERATING AND INSTALLATION FEATURES

MANUEL D'INSTRUCTIONS

CARATERISTIQUES DE FONCTIONNEMENT ET INSTALLATION

MANUAL DE ISTRUCCIONES

CARACTERÍSTICAS DE FUNCIONAMIENTO E INSTALACIÓN

T-LINE

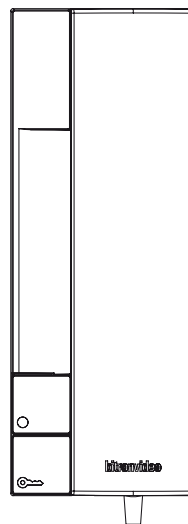

AV1407/010

CITOFONO UNIVERSALE T-LINE
T-LINE UNIVERSAL DOOR PHONE
COMBINÉ UNIVERSEL T-LINE
INTERFÓNO UNIVERSAL T-LINE

ITALIANO

CARATTERISTICHE

Le principali caratteristiche del citofono universale AV1407/010 sono le seguenti:

1. installazione in impianti 4+n (5 fili) e in impianti 1+n (2 fili) con qualsiasi modello di pulsantiera
2. possibilità di avere chiamata tradizionale su ronzatore o chiamata elettronica sull'altoparlante del microtelefono
3. regolazione o esclusione di chiamata elettronica per mezzo di un commutatore a slitta a tre posizioni:
 - volume massimo;
 - volume minimo;
 - esclusione di chiamata (segnalata mediante la fuoriuscita di una bandierina di segnalazione rossa dal corpo del citofono).
4. possibilità di regolare il volume della fonia entrante (altoparlante del microtelefono)
5. possibilità di regolare il volume della fonia uscente (microfono del microtelefono)

✓ Di fabbrica il citofono è configurato per fonia 4+n e chiamata su ronzatore.

DESCRIZIONE DEI MORSETTI

Collegamenti della morsettiera in funzione del tipo di impianto			
2 fili (1+n)		5 fili (4+n)	
APP	Non connesso	APP	Chiamata a ronzatore o elettronica
1	Collegamento di massa dell'impianto	1	Fonia entrante (altoparlante)
2	Fonia/chiamata	2	Fonia uscente (microfono)
6	Non connesso	6	Massa impianto
OP	Collegare al morsetto 1 del citofono	OP	Da collegare al morsetto 6 del citofono
OP	Collegare al morsetto 2 del citofono	OP	Apriporta
Au	Contatto ausiliario libero	Au	Contatto ausiliario libero
Au	Contatto ausiliario libero	Au	Contatto ausiliario libero

INSTALLAZIONE

Procedura di montaggio su muro:

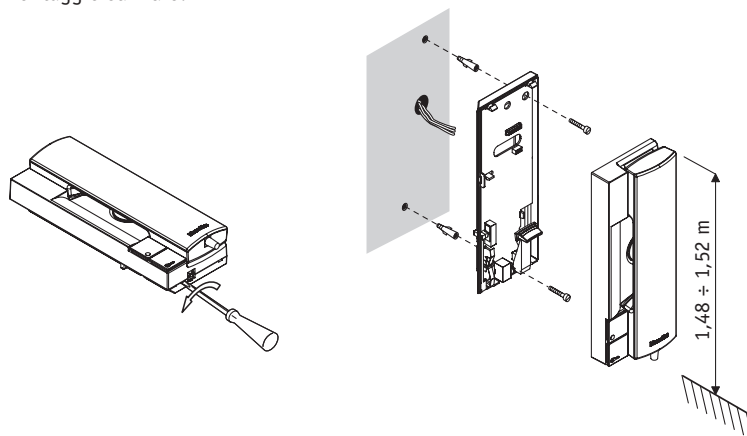

IMPIANTI 4+N

Per impianti 4+n (5 fili) settare i jumper JP1÷JP5 tutti nella posizione "5", come mostrato nella foto (configurazione standard):

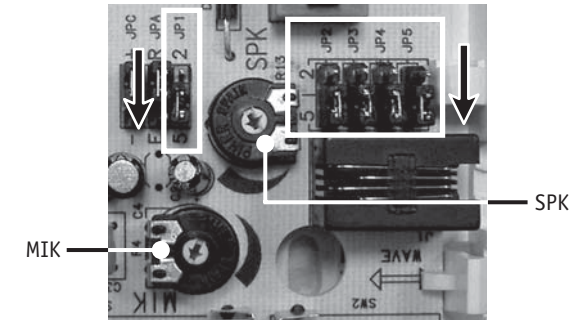

In caso di fonia tradizionale, lasciare i trimmer MIK e SPK come mostrato nella foto. In caso di fonia elettronica, ruotare il trimmer SPK tutto in senso orario.

IMPIANTI 1+N

- Lasciare il jumper JPC nella posizione "+"

Per impianti 1+n (2 fili) settare i jumper JP1÷JP5 tutti nella posizione "2", come mostrato nella foto:

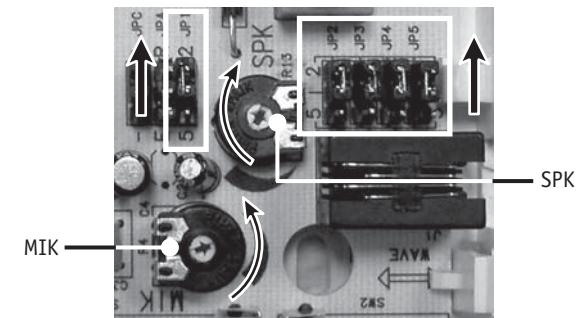

Ruotare il trimmer SPK tutto in senso orario. Ruotare il trimmer MIK a circa metà corsa.

CHIAMATA SU RONZATORE

- Posizionare il jumper JPA nella posizione "R".

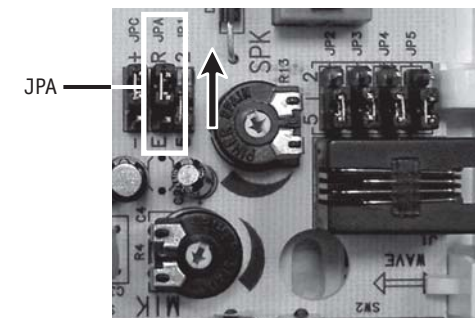

CHIAMATA ELETTRONICA SU ALTOPARLANTE DEL MICROTELEFONO

- Posizionare il jumper JA nella posizione "E".

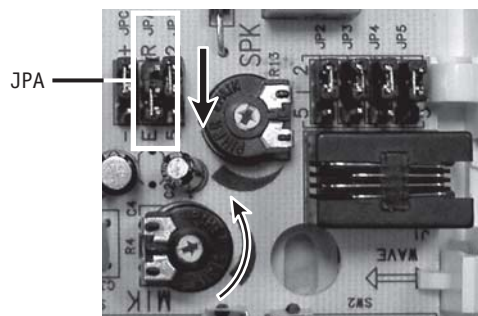

COLLEGAMENTO

IMPIANTI 4+N

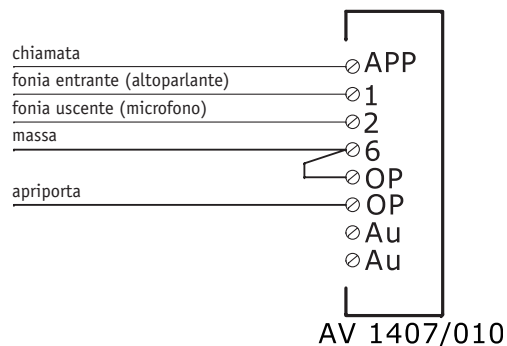

IMPIANTI 1+N

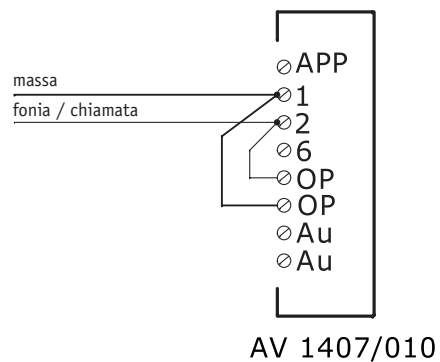

CHARACTERISTICS

The main characteristics of AV1407/010 universal door phone are the following:

1. installation in 4+n (5 wires) systems and in 1+n (2 wires) systems with any kind of push button panel.
2. possibility to have traditional call on buzzer or electronic call on handset loudspeaker
3. electronic call adjustment or disabling by a slide switch with three positions.
 - Maximum volume;
 - Minimum volume;
 - call disabling (this is signalled by a little red flag, that comes out of the door phone body)
4. possibility to adjust the incoming speech signal volume (handset loudspeaker)
5. possibility to adjust the outgoing speech signal volume (handset loudspeaker)

✓ By default the door phone is configured for 4+n signals and for call on buzzer.

TERMINAL PINS DESCRIPTION

Terminal strip connections according to the system wiring			
2 wires (1+n)		5 wires (4+n)	
APP	Not connected	APP	Call tone by buzzer or electronic
1	System ground	1	Incoming speech signal (loudspeaker)
2	Speech signal/call tone	2	Outgoing speech signal (microphone)
6	Not connected	6	System ground
OP	Connect to door phone terminal pin 1	OP	To be connected to the door phone terminal pin 6
OP	Connect to door phone terminal pin 2	OP	Door opener
Au	Free auxiliary contact	Au	Free auxiliary contact
Au	Free auxiliary contact	Au	Free auxiliary contact

INSTALLATION

Wall mounting procedure:

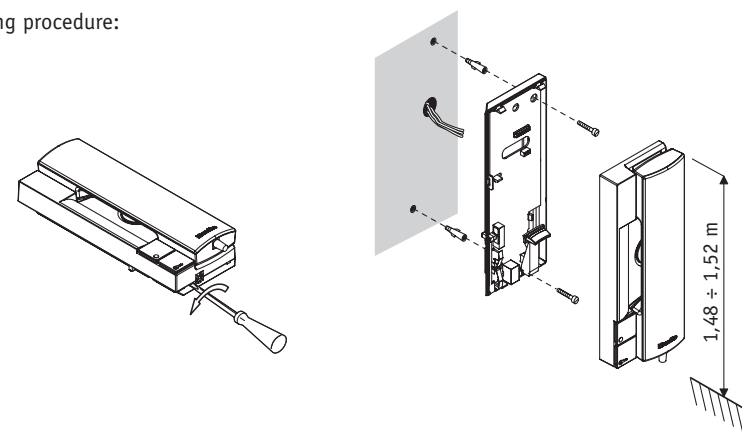

4+N SYSTEMS

For 4+n (5 wires) systems, put all the jumpers JP1÷JP5 in position “5”, as shown in the photo (standard configuration):

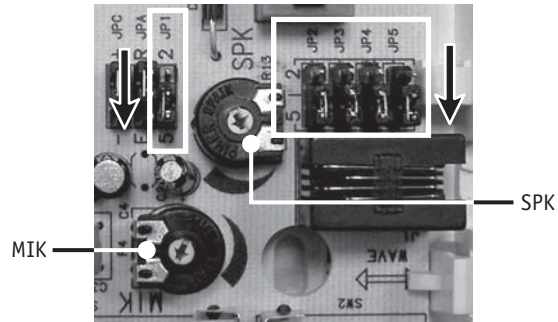

In case of traditional speech signal, set the trimmers MIK and SPK as shown in the photo.
In case of electronic speech signal, rotate all the trimmer SPK clockwise.

1+N SYSTEMS

- Leave the jumper JPC in “+” position.

For 1+n (2 wires) systems, put all the jumpers JP1÷JP5 in position “2”, as shown in the photo:

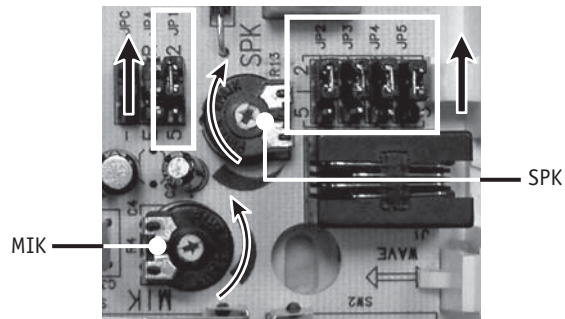

Rotate all the trimmer SPK clockwise.
Rotate the trimmer MIK at about central stroke position.

CALL BY BUZZER

Put the jumper JPA in position “R”.

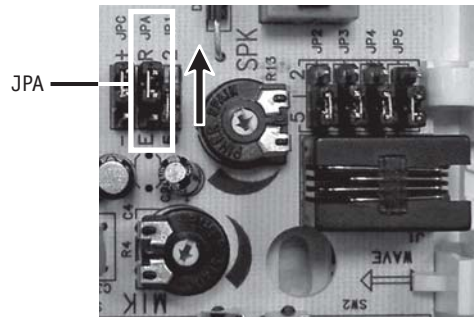

ELECTRONIC CALL BY HANDSET LOUDSPEAKER

- Put the jumper JPA in position “E”.

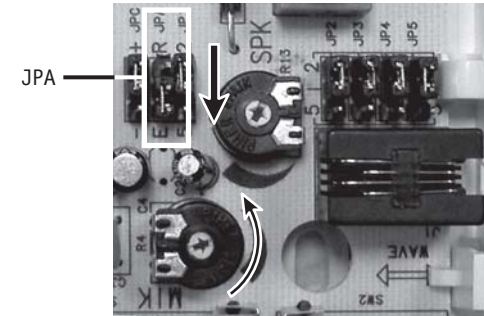

CONNECTIONS

4+N SYSTEMS

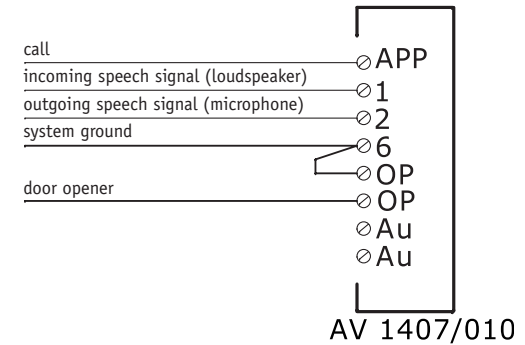

1+N SYSTEMS

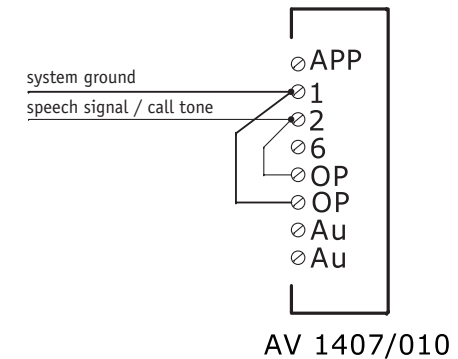

FRANÇAIS

CARACTÉRISTIQUES

Les caractéristiques principales de l'interphone universel AV1407/010 sont les suivantes:

1. installation dans les systèmes 4+n (5 fils) et dans les systèmes 1+n (2 fils) avec toute plaque de rue
2. possibilité d'avoir un appel traditionnel avec ronfleur ou un appel électronique avec le haut-parleur du combiné
3. réglage ou exclusion d'appel électronique par le biais d'un interrupteur à coulisse avec trois positions:
 - volume maximum;
 - volume minimum;
 - exclusion d'appel (signalée par la sortie d'un petit drapeau rouge de signalisation du combiné).
4. possibilité de régler le volume de la phonie montante (haut-parleur du combiné)
5. possibilité de régler le volume de la phonie descendante (microphone du combiné)

✓ En usine le combiné est configuré pour une installation 4+n et appel avec ronfleur.

DESCRIPTION DES BORNES

Branchements du bornier en fonction du type de système			
2 fils (1+n)		5 fils (4+n)	
APP	Non connecté	APP	Appel avec ronfleur ou électronique
1	Masse du système	1	Phonie montante (haut-parleur)
2	Phonie/appel	2	Phonie descendante (microphone)
6	Non connecté	6	Masse du système
OP	Connecter à la borne 1 du combiné	OP	A connecter avec la borne 6 du combiné
OP	Connecter à la borne 2 du combiné	OP	Ouvre-porte
Au	Contact auxiliaire libre	Au	Contact auxiliaire libre
Au	Contact auxiliaire libre	Au	Contact auxiliaire libre

INSTALLATION

Procédure d'installation murale:

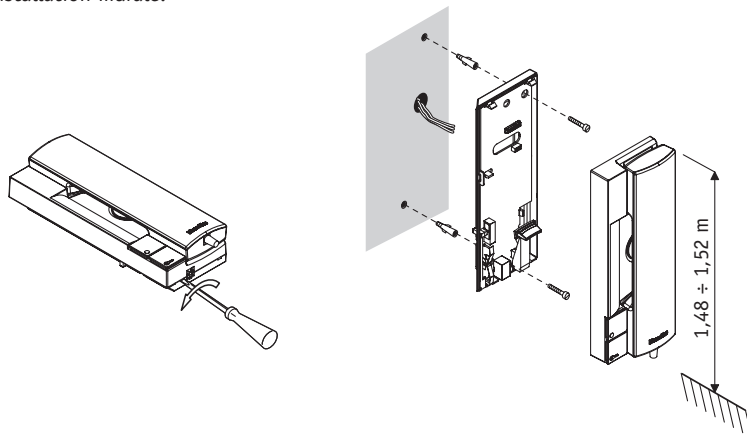

SYSTÈMES 4+N

Pour les systèmes 4+n (5 fils), configurer tous les jumpers JP1 à JP5 en position "5", comme illustré sur la photo ci-dessous (configuration standard).

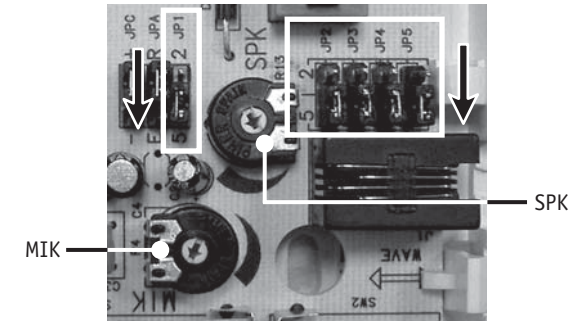

Dans le cas de phonie traditionnelle (capsule charbon), laisser les trimmers MIK et SPK comme illustré sur la photo. Dans le cas de phonie électronique (micro-électret), tourner le trimmer SPK à fond dans le sens des aiguilles d'une montre.

SYSTÈMES 1+N

- Laisser le jumper JPC en position "4".

Pour les systèmes 1+n (2 fils) configurer tous les jumpers JP1 à JP5 en position "2", comme illustré sur la photo ci-dessous:

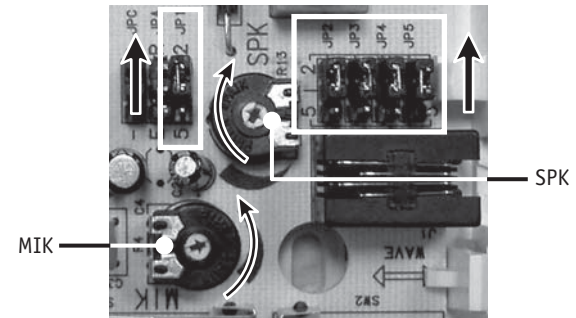

Tourner le trimmer SPK à fond dans le sens des aiguilles d'une montre
Tourner le trimmer MIK environ à moitié course.

APPEL AVEC RONFLEUR

Positionner le jumper JPA en position "R".

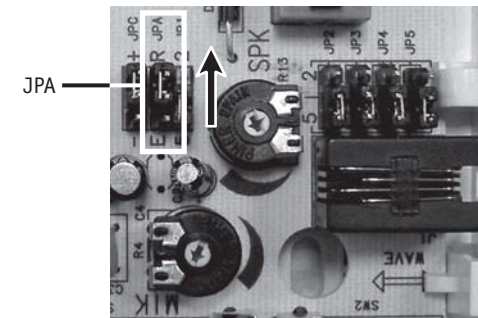

APPEL ÉLECTRONIQUE SUR LE HAUT-PARLEUR DU COMBINÉ

- Positionner le jumper JPA en position "E".

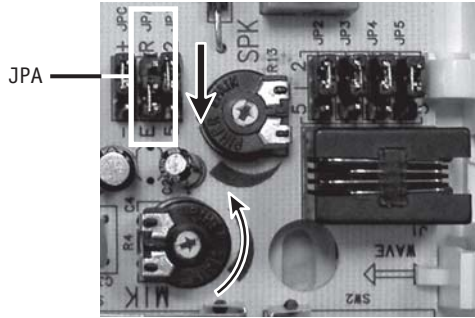

BRANCHEMENTS SYSTÈMES 4+N

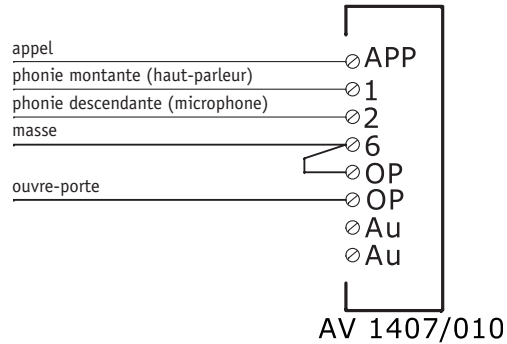

SYSTÈMES 1+N

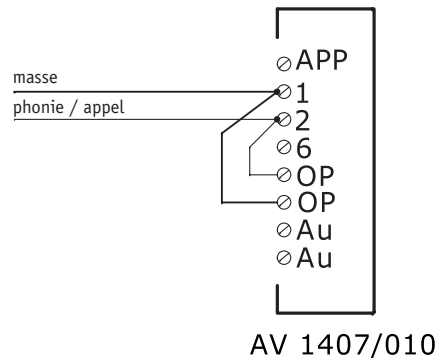

ESPAÑOL

CARACTERÍSTICAS

Las principales características del interfono universal AV1407/010 son las siguientes:

1. instalación en sistemas 4+n (5 hilos) y en sistemas 1+n (2 hilos) con todas le caja de pulsadora
2. posibilidad de recibir llamada tradicional en timbre trepidante o llamada electrónica en el altavoz del microteléfono
3. regulación o exclusión de llamada electrónica por medio de un conmutador con corredera con tres posiciones:
 - volumen máximo;
 - volumen mínimo;
 - exclusión de llamada (indicada mediante el escape de un banderín de aviso rojo de adentro del interfono).
4. posibilidad de regular el volumen de la fonía en entrada (altavoz del microteléfono)
5. posibilidad de regular el volumen de la fonía en salida (altavoz del microteléfono)

✓ De producción el interfono esta activado como función 4+n y llamada en timbre trepidante.

DESCRIPCIÓN DE LOS BORNES

Conexión de la caja de bornes según el tipo de sistema			
2 hilos (1+n)		5 hilos (4+n)	
APP	No conectado	APP	Llamada hacia timbre trepidante o electrónica
1	Conexión de masa del sistema	1	Fonía en entrada (altavoz)
2	Fonía/llamada	2	Fonía en salida (micrófono)
6	No conectado	6	Masa sistema
OP	Conectar en el borne 1 del interfono	OP	Conectar en el borne 6 del interfono
OP	Conectar en el borne 2 del interfono	OP	Apertura de puerta
Au	Contacto auxiliar libre	Au	Contacto auxiliar libre
Au	Contacto auxiliar libre	Au	Contacto auxiliar libre

INSTALACIÓN

Procedimiento de montaje en la pared:

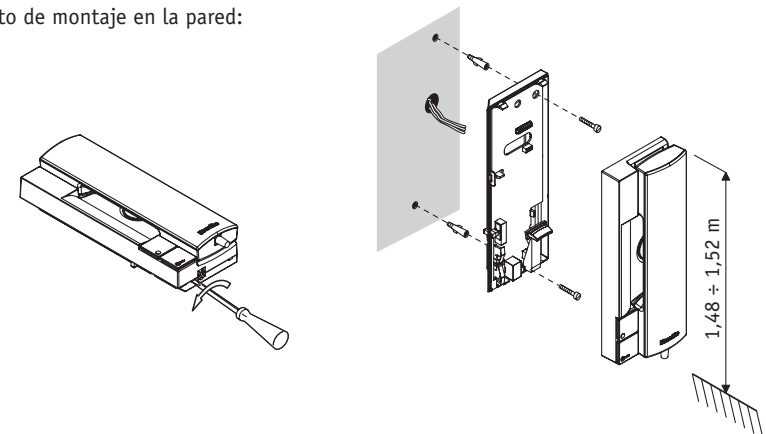

SISTEMAS 4+N

Para sistemas 4+n (5 hilos) posicionar los puentes de conexión JP1÷JP5 todos en la posición "5", como indicado en la foto (configuración estándar):

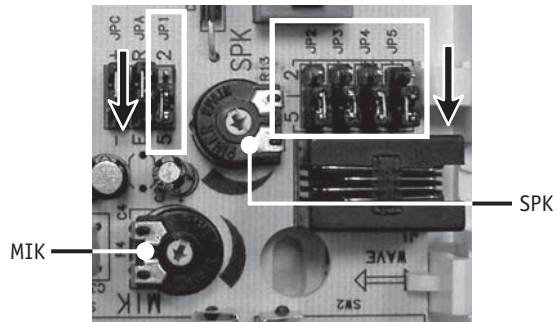

En el caso de fonía tradicional, dejar el trimmer MIK y SPK como indicado en la foto.
En el caso de fonía electrónica, girar el trimmer SPK todo en sentido orario.

SISTEMAS 1+N

- Dejar el puente JPC en la posición "+".

Para sistemas 1+n (2 hilos) posicionar los puentes de conexión JP1÷JP5 todos en la posición "2", como indicado en la foto:

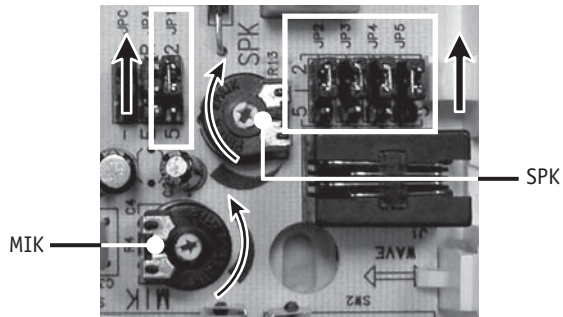

Girar el trimmer SPK todo en sentido orario.
Girar el trimmer MIK hasta casi mitad recorrido.

LLAMADA HACIA TIMBRE TREPIDANTE

Posicionar el puente de conexión JPA en la posición "R".

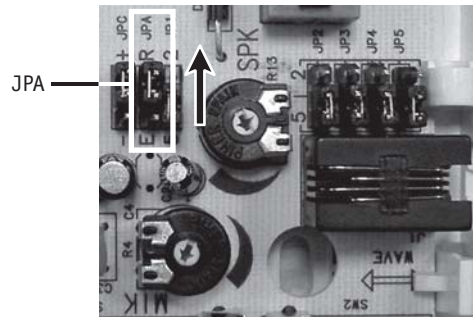

LLAMADA ELECTRÓNICA HACIA ALTAVOZ DEL MICROTELÉFONO

- Posicionar el puente de conexión JPA en la posición "E".

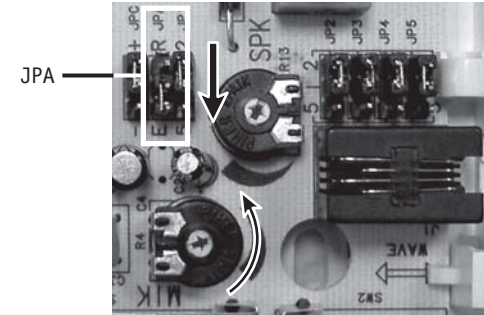

CONNEXION SISTEMAS 4+N

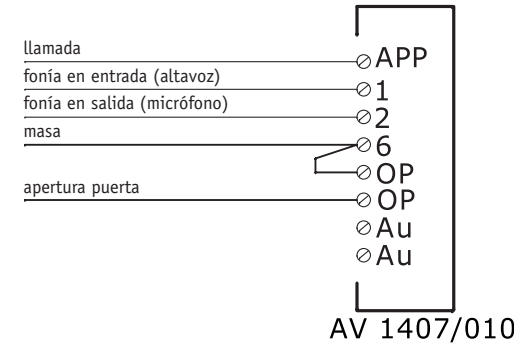

SISTEMAS 1+N

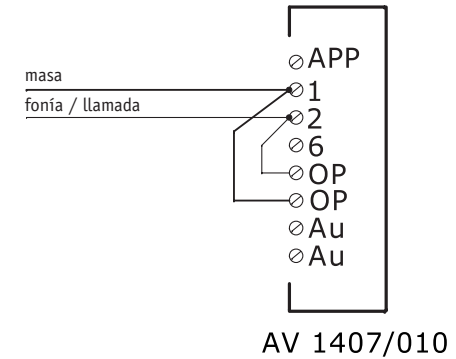

IMPIANTO CITOFONICO (SISTEMA "1 + n"), CON 1 POSTO ESTERNO, CHIAMATA ELETTRONICA
"1 + n" DOOR PHONE SYSTEM, WITH ELECTRONIC CALL FROM 1 VISITOR PANEL
SISTEME DE PORTIER "1+n" AVEC UNE PLAQUE DE RUE, APPEL ELECTRONIQUE
SISTEMA INTERFONICO "1+n" CON 1 PLACA EXTERIOR, LLAMADA ELECTRONICA

All rights reserved - Diritti riservati a Norma di Legge

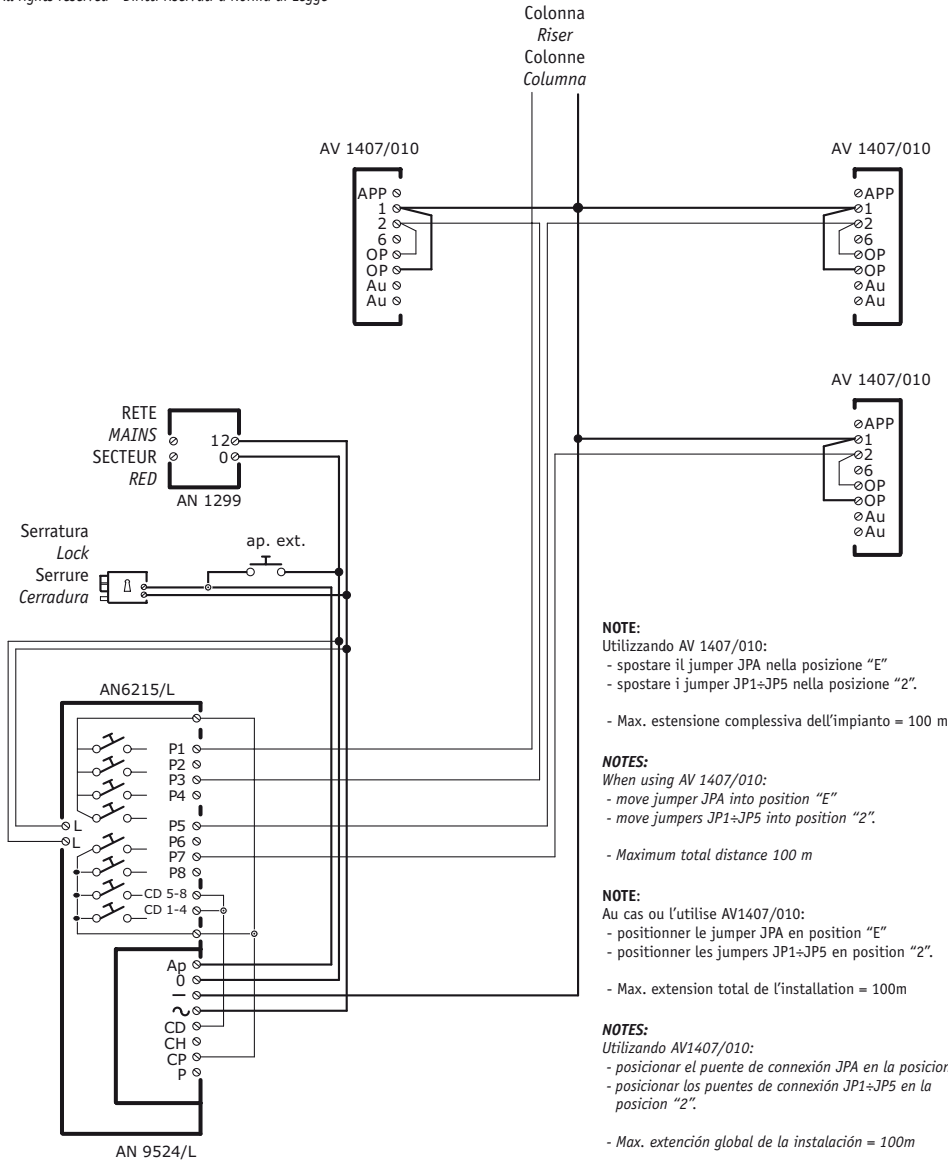

IMPIANTO CITOFONICO (SISTEMA "4 + n"), CON 1 POSTO ESTERNO, CHIAMATA ELETTRONICA
"4 + n" DOOR PHONE SYSTEM, WITH ELECTRONIC CALL FROM 1 VISITOR PANEL
SISTEME DE PORTIER "4+n" AVEC UNE PLAQUE DE RUE, APPEL ELECTRONIQUE
SISTEMA INTERFONICO "4+n" CON 1 PLACA EXTERIOR, LLAMADA ELECTRONICA

All rights reserved - Diritti riservati a Norma di Legge

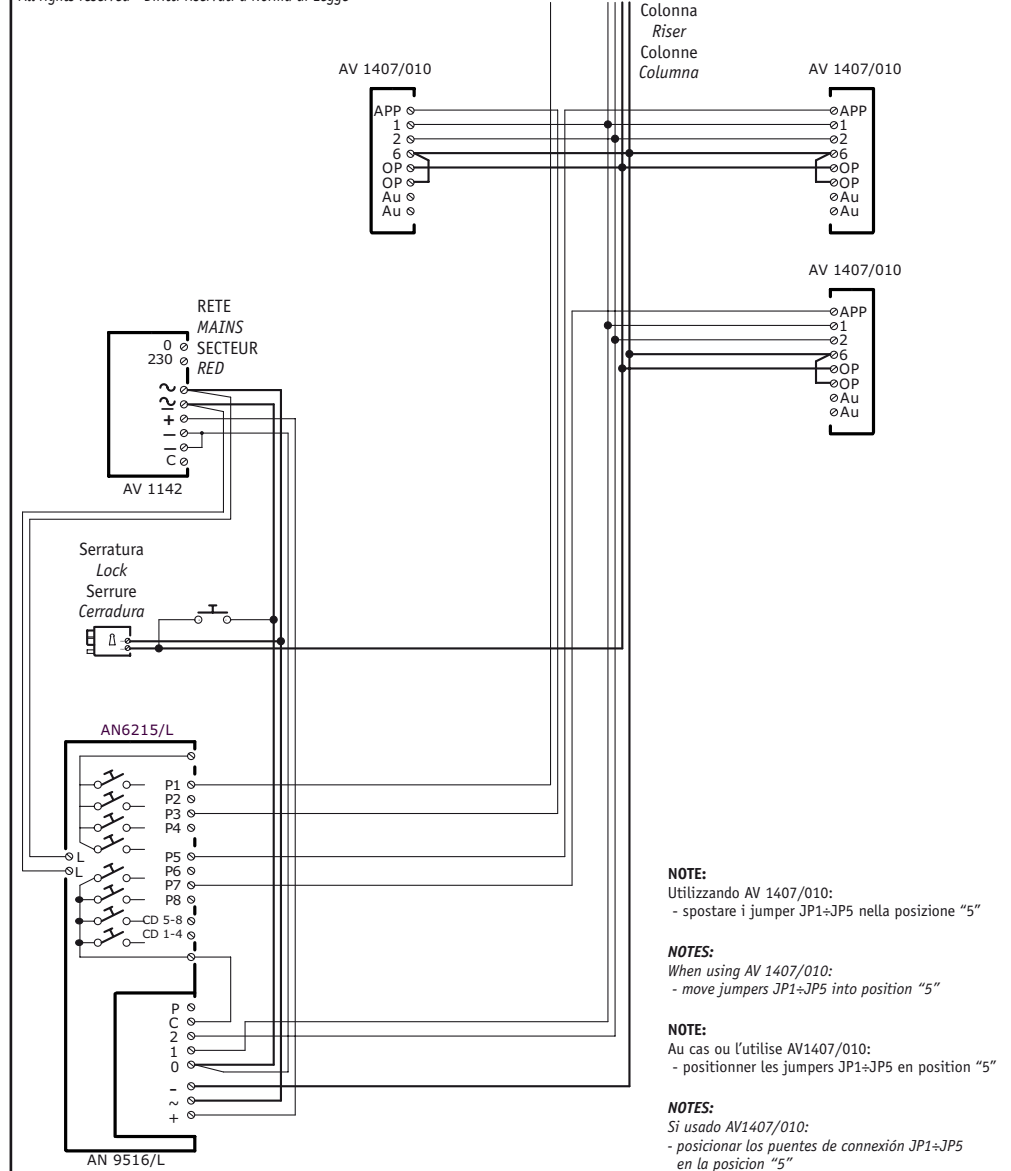

AV1407/010	OP / OP	2	6	1	APP (E)	APP (R)
Casa costruttrice Manufacturer Marque Fabricante	Apertura porta Door opener Ouverture de porte Apertura de puerta	Fonia uscente Outgoing speech signal Phonie descendante Fonia en salida	Massa Ground Masse Masa	Fonia entrante Ingoing speech signal Phonie montante Fonia en entrada	Chiamata elettronica Electronic call tone Appel électronique Llamada electronica	Chiamata su buzzer Call tone by buzzer Appel ronfleur Llamada en zumbador
ACET	5	10	2	7	9	
ACET-ANTENOPHONE	5	10	2	7		9
ACET-ANTENOPHONE	7	3	6	4		5
AIPHONE (poste CVK)	4	1	3	2	B	
AMPER	D	A	C	B	E	
AMPLIVOX	Z	T	0	R		1
AMPLIVOX	Z	8	0	T		1
AMPLIVOX	2	T	0	R		1
ATEA	2	4	3	1	5	
AUTA TF92	10	3	4	7	12	
AUTELCO	P5	a	1	b	2	
BELL SYSTEM TELEPHO.	Z	R	0	T	I	
BITRON VIDEO	9	2	6	1	C7	11
BOGEN	T	1	3	2	6	
BPT	2	1	4	5	3	
CENTRAMATIC	4	2	1	3	5	
CEVAM	2	6	9	4		R
CITESA	1	4	C	3	B	
CITOFONIX	3	1	2	4		5
CITOVVOX	5	10	9	7	T	
COFREL TERANEO LT	T	2	3	1		6
COMELIT	5	3/6	4	2	1	
ELBEX		MIC	LOW	SPEC	+	
ELBOX	2	6	9	4	+	
ELBOX	7	2	3/4/5	1	6	
FARFISA	5	1	3	2	6	
FERMAX	1	2	3	6	4	
FERMAX 2044,20440,21100	1	2	3	6	4	
FERMAX GONDOLA	4	1	3	2	V/5	
FERMAX REKTO TF-4	P	A	C	B	E	
FRINGE	2	3	1	6	4	
GAME	P	2	3	1	Z	
GIRO	2	3	1	6	4	
GOLMAR	X	M	A	S	N	
GOLMAR	C2	5	3	10	7	
GOLMAR	11	5	3	4	12	
GOLMAR T-2800	4	5	3	10	7	

AV1407/010	OP / OP	2	6	1	APP (E)	APP (R)
Casa costruttrice Manufacturer Marque Fabricante	Apertura porta Door opener Ouverture de porte Apertura de puerta	Fonia uscente Outgoing speech signal Phonie descendante Fonia en salida	Massa Ground Masse Masa	Fonia entrante Ingoing speech signal Phonie montante Fonia en entrada	Chiamata elettronica Electronic call tone Appel électronique Llamada electronica	Chiamata su buzzer Call tone by buzzer Appel ronfleur Llamada en zumbador
GOLMAR T-600	T	1	3	2	6	
LT TERRANEO COFREL	T1	1	3	2	6	
OSTELVI	9	2	6	1	7	
PORMAT	4	3	2/5	1	v	
RIPOLLES	3	1	8	2	4	
RITTO ELEGANT 40518	11	12	13	15	14	
SAFNAT	4	1	2	3	v	
SEITI	5	1	3	2	6	
SIEDLE HTA 711-01	I	12	9/C	11	7	
SPRINT	"/"	1	3	2	6	
STR NH200	1	M	0	T	S	
STR NH205	1	M	0	T	S	
TAGRA	8	2	6	1	4	
TEGUI GL	3	4	2	5	1	
TEGUI HORIZON (elec.)	3	4	2	5	1	
TEGUI HORIZON (Zum.)	3	4	2	5	1	
TELEVES	4	2	3	1	T	
TESLA DDZ 85	1	2	3	6	4	
TESLA DDZ 93	z	2	3	6	4	
TUNE	8	2	6	1	4	
URMET	8/9	2	11	1	7	
URMET	9	2	6	1	7	
URMET	9	2	6	1	CA	7
VIDEX	5	1	7	2	6	
YUS PHONE	EL	T	-	R	B/PT	
TRANSIFON	1	5	6	7		4
VEMEL	5	2	3	4		1
VIDEX	5	1	7/3	2	4	6
VISIODIS (OKAY)	5	2	4	3/6		1

bitronvideo

VIDEOCITOFONIA - TVCC

Bitron Video adotta una politica di continuo sviluppo. Bitron Video si riserva il diritto di effettuare modifiche e miglioramenti a qualsiasi prodotto descritto nel presente documento senza preavviso.

Bitron Video follows a policy of continuous evolution of its products. Therefore Bitron Video reserves the right to introduce changes or modifications all its products in any moment and without prior notice.

Bitron Video applique une méthode de développement continu. Par conséquent, Bitron Video se réserve le droit d'apporter des changements et des améliorations à tout produit décrit dans ce document, sans aucun préavis.

Bitronvideo sigue una política de constante desarrollo; por lo tanto, se reserva el derecho de aportar modificaciones y mejoras a cualquier producto descrito en este documento sin aviso previo.

BITRON VIDEO S.r.l.

Via Albenga, 125

10090 Rivoli, Cascine Vica (Torino) Italy

Tel. +39 011 5531700 (r.a.) - Fax +39 011 5531720

<http://www.bitronvideo.it>

e-mail: info@bitronvideo.it

Designed in Italy

Assembled in PRC